

BEFORE YOU START

General Site Working

BS 8000 Workmanship on building sites, Parts 13 through to 16 with respect to above ground drainage and sanitaryware appliances are relevant in general terms.

Handling and Storage

Gutters, downpipes and fittings, particularly with painted finish should be handled with care and preferably stored under cover on racks to prevent scratching. Whilst it is not known to pose any health hazard, it is recommended that protective gloves be worn when handling cast iron material. All painted lengths are supplied in a protective polythene wrapping with components similarly wrapped and stored in cardboard boxes. If painted product is to be stored outside, cover with a tarpaulin to protect against rainfall and direct sunlight. Failure to do this may allow water to get trapped inside the protective wrapper and could lead to permanent watermarks on the paint finish. All primed products should have an additional primer coat, undercoat and top coat (in accordance with paint manufacturer’s instructions) applied prior to being fitted.

Cutting and Drilling

Gutter sections may be cut on site using either an angle grinder or reciprocating saw fitted with appropriate meal diamond blade. Drilling should be done with diamond tipped drill bit. Where gutters or fittings are painted, then cut edges should be de-burred and then repainted with touch-up paint (available from ARP).

Setting Out

Cast Iron gutters must be installed a minimum fall of 1:600. When setting out for this fall it is imperative to identify the lowest and highest point. The lowest point needs to be the outlet, so mark this position first, followed by the highest point which will be the end of the run. A string line can then be used between these points to identify regular points of reference.

Materials Checklist

- Spirit level/straight edge
- Suitable screwdriver/attachment
- Sealant caulking gun
- Pencil or chalk
- String or laser line
- Hacksaw/electric jigsaw/chopsaw
- Tape measure
- Small wrench

Jointing

Any use of sealant must not be carried out in wet weather or in temperatures below 5°C or above 50°C. All Joint surfaces must be perfectly clean and dry. Only a low modulus sealant must be used to prevent early failure. Ensure that the gutter joint sockets/spigots are correctly aligned with each other to ensure free thermal movement (3-4mm) within the gutter joint.

Fixing

It is important that all fixings are suitable for both the substrate and the load. They must therefore be of the appropriate size and of a compatible material to ensure no electrolytic corrosion occurs. ARP recommends that stainless steel (preferably austenitic) screws must be used to fix gutters, whether direct, fascia or rafter bracket fixed.

Gutter Position

The current recommendations from the Metal Gutter Manufacturers Association (MGMA) is to position gutters as Fig 1.

Fig 1. As the line of the roof passes the gutter, a good proportion of debris sliding down the roof, such as leaves or snow will pass by without being collected. This position will also reduce potential snow build up back up the roof, which can put additional strain on brackets and fascia board adhesion.

There are certain conditions where a Fig 1 installation might allow water to over shoot the gutter in high wind conditions however this is deemed to be better than the above stated issues.

Fig 2. As the line of the roof sits inside the gutter profile, this encourages

debris, such as leaves or snow, to be collected and could cause an increase in debris clearing regularity and issues with bracket and fascia board adhesion strength in heavy snow conditions.



Installation Guide for HALF ROUND & VICTORIAN OGEE SYSTEMS

GUTTER FIXING

We advise that you ensure the fixing background (e.g. fascia board) is securely fixed, level and able to support the weight of the gutter at full capacity and that the roof overhang is correct (see gutter position).

Britannia cast iron gutters are fitted using fascia brackets. Buildings without fascias may need a different type of bracketry. ARP offers rise & fall brackets and rafter brackets as options, however due of the variety of installations these do not suit BS/EN levels regarding loading, so advice should be sought from ARP on parameters of use.

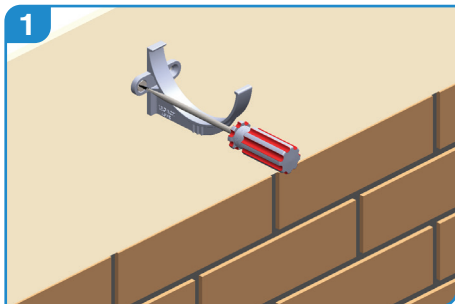

1 Identify the highest and lowest point of the gutter run and install brackets on each end ensuring a minimum fall of 1:600.

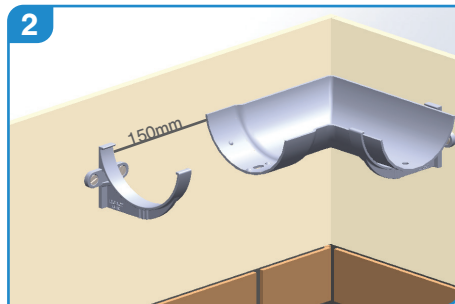
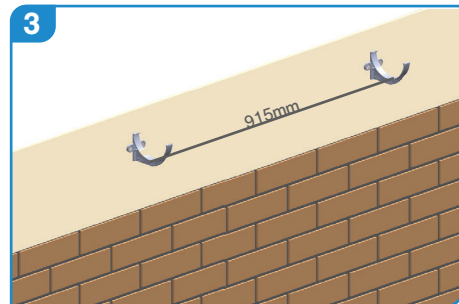
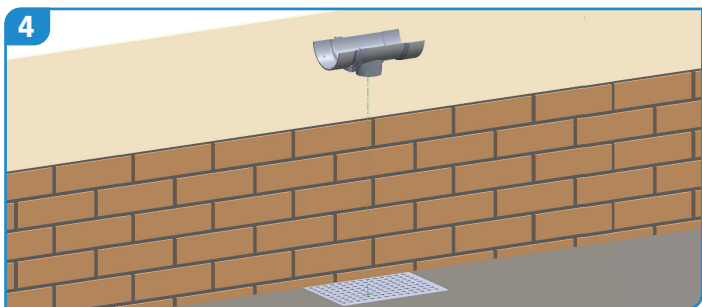

Image 2 shows the ideal bracket positioning for the angle and bracket to take the gutter length. (Max 150 mm from joint).



3 We recommend fixing brackets every 915mm and using an additional bracket for each outlet or angle.

Ideally using a string line or laser level between the two brackets, set out intermediate brackets at maximum centres of 915mm.



4 With the use of a plumb or laser line, position outlets over gullies and support with at least one bracket. Also include a bracket per angle (internal or external).

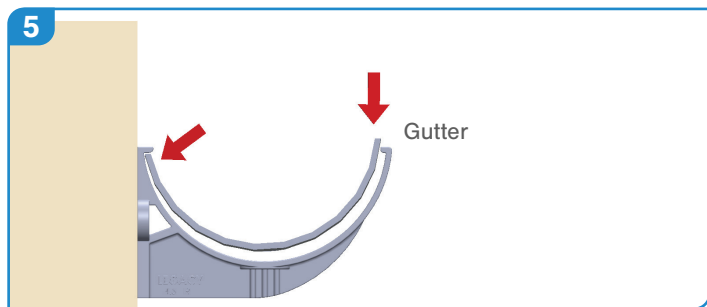

5 When fitting outlets and angles position the rear face of the gutter underneath the roof finish. Locate the gutter into the fascia bracket and then clip the front edge down into position.

After fitting outlets and angles, proceed with fitting the gutter lengths using the same method.



6 Ensure that all fixing surfaces are clean and dry. Apply 2 x 6mm beads of low modulus sealant into the socket end of gutter, place gutter length into sealant/socket.

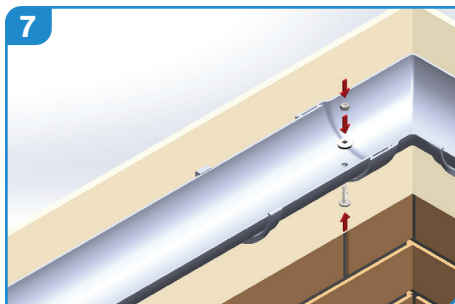

7 Push bolt through the sole of the gutter socket ensuring that the slot is filled with sealant before applying nut and washer, gently tighten. Do not overtighten as this may force the sealant out of the joint.

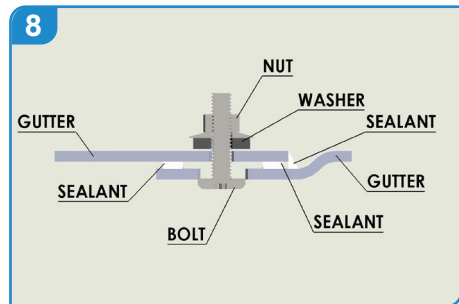

8 Clean off any excess sealant to either side of the joint. Apply additional sealant as required to the internal face only to create a smooth bead.

N.B. Union connectors are available to allow the use of cut lengths.



Any cut lengths should be de-burred and touched up with touch-up paint supplied prior to installation. For more information or further assistance, please contact us.